

ATEX certified Vacuum Pumps and Compressors



ATEX: Safety First

Since July 1, 2003, it is compulsory by law to certify explosion-proof equipment according to ATEX 94/9 EG. Free trade within the EC for ATEX compliant machines and equipment is the goal of this European standardization of machine requirements. ATEX also covers non-electric devices that are a potential ignition source. A subdivision "Gas/particle(dust) explosion protection" according to ATEX is marked as G (as)/D (ust).

The „zones“ (according to RL 1999/92/EG) represent work areas in which an explosive atmosphere can occur. Depending on the frequency and the duration of the explosive atmosphere, ATEX defines different zones and corresponding categories:

- **„Continuously or for longer periods of time“**
Zone 0 (=G) und 20 (=D) Equipment category 1
- **„Occur occasionally“**
Zone 1 (=G) und 21 (=D) Equipment category (1 or) 2
- **„Normally not likely to occur, or only for short periods of time“**
Zone 2 (=G) und 22 (=D) Equipment category (1, 2 or) 3
- Only equipment, components and protective devices may be placed on the market which conform to the provisions of ATEX directive 94/9/EG.

ATEX equipment directive 94/9/EG (ATEX 95)

- For the first time non-electrical equipment was included in this directive.
- Only equipment, components and protective devices may be placed on the market which conform to the provisions of ATEX directive 94/9/EG.

ATEX workplace directive 99/92/EG (ATEX 137)

- Assembling, installing and operation of equipment in potentially explosive atmospheres.

Elmo Rietschle offers a choice of ATEX compliant equipment from all our vacuum and pressure technologies.



Applications

Chemical and pharmaceutical industry

- De-gassification
- Distillation
- Drying

Environmental engineering

- Biogas compression
- Gas re-injection
- Natural gas compression



Definitions

Our equipment, components and protective devices are assigned to equipment group II (not mining industry). The following information must be submitted to determine the Ex-classification:

- Category (i) (o)
- Explosion group (i) (o)
- Temperature class (i) (o)



Example of identification for category 1

EC Type Examination Certificate No. e.g. IBExU 04 ATEX 1184 X

CE 0637 Ex (i) II 1 G c IIB T3

CE-conformity marking

Identification number of certifying body (IBExU = 0637)

Ex - Hexagon

Output / environment (i) = Inside
(o) = Outside

Equipment group I = Mining industry
II = Not mining industry

Equipment category 1 = Extremely high safety level
2 = High safety level
3 = Normal safety level

Ex-atmosphere G = Gas
D = Dust

Type of protection c = Constructive safety

Explosion group IIA, IIB, IIC

Temperature class T1, T2, T3, T4, T5, T6



Category

Equipment group II (not mining industry)

	Category 1		Category 2		Category 3	
Permanent danger	Continuously, frequently or over a long period of time		Occasionally		Rarely and over a short period of time	
Requirement	Very high safety		High safety		Normal safety	
Zone	Zone 0	Zone 20	Zone 1	Zone 21	Zone 2	Zone 22
Material group	G	D	G	D	G	D

G = Gas, D = Dust

Explosion groups

Gases and vapors are classified in three explosion groups (IIA, IIB und IIC) based on their flammability. The danger increases from explosion group IIA to IIC. (The higher explosion groups for example include, in any case, the lower groups IIB and IIA).

Temperature classes

The following permissible maximum surface temperatures of equipment apply (the higher temperature class T6 for example, includes the lower temperature classes T5 to T1):

Explosion groups in accordance with CENELEC, IEC, NEC 505

Explosion group	Typical gas
I	Methane
IIA	Propane
IIB	Ethylene
IIC	Hydrogen

Maximum surface temperature	CENELEC IEC USA (NEC 505)
450°C	T1
300°C	T2
200°C	T3
135°C	T4
100°C	T5
85°C	T6

	T1	T2	T3	T4	T5	T6
I	Methane					
IIA	Acetone Ethane Ethyl acetate Ammonia Benzene (pure) Acetic acid Carbon monoxide Methane Methanol Propane Toluene	Ethanol i-amyl acetate n-butane n-butyl alcohol	Gasoline Diesel fuel Aircraft fuel Fuel oils / Heating oils n-hexane	Acetyl aldehyde Ethyl ether		
IIB	Coal gas (city gas)	Ethylene				
IIC	Hydrogen	Acetylene				Hydrogen acetyline carbon disulphide

Product overview

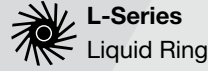
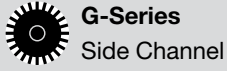

G-BH1

Classics with innovative technology

With their high inlet volume flow up to 2,500 m³/h and a differential pressure of up to 780 mbar, our low noise G-BH1 side channel blowers have earned their reputation. They are reliable, low maintenance and durable. They deliver 20,000 operating hours without fail and are virtually maintenance free.

G-BH7

Unsurpassed at highest differential pressure

Our high performance G-BH7 side channel blowers can create differential pressure of up to 1,000 mbar. They deliver 20,000 operating hours without fail and are virtually maintenance free.

ATEX marking for side channel blowers

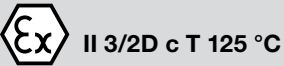

L-BV2

Multi-purpose liquid ring pumps

Our L-BV2 liquid ring pumps are high-powered and multi-talented machines which save space and up to 50 % in operating liquids. The machines are available in various combinations of materials such as stainless steel, bronze, ceramic and cast iron with ceramic coating.

L-BV5

Monoblock pumps with the highest volume flow

The block pumps in the L-BV5 family are characterised by a very high suction volume of up to 600 m³/h with suction pressures of up to 33 mbar (abs.) and are primarily used for applications with large quantities of liquids. The L-BV5 also simultaneously works as a condenser while suctioning condensable vapor. This enables the suction volume to be doubled. Reinforced stainless steel shafts, continuously lubricated bearings and a coated pump housing prevent wear and tear caused by solids that are also sucked in, and guarantee constant performance, even after many years of use.

ATEX marking for liquid ring pumps

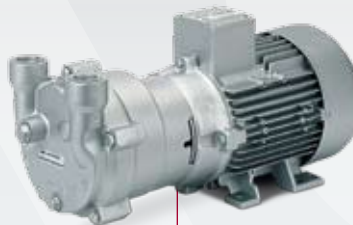

Certified ATEX categories

G-BH1

Inside up to 3G T3 & 3D T 125 °C
Outside up to 2G T3 & 2D T 125 °C

G-BH7

up to 3G T3 & 3D T 125 °C
up to 2G T3 & 2D T 125 °C

L-BV2

up to 2G T3
up to 2G T3

L-BV5

up to 2G T3
up to 2G T3

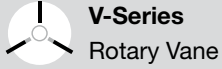

V-Series
Rotary Vane

V-VWZ

Two stage rotary vane vacuum pump with internal water cooling. Capacities ranging from 100 to 1,200 m³/h. Ultimate vacuum at 0.5 mbar (abs.). Thanks to its once through oil lubrication it is suitable for handling aggressive gases. The flange motors comply with DIN EN 60034 and have protection class IP 54 and isolation class F.

V-VLV

Two-stage rotary vane vacuum pump in vertical design. Capacities ranging from 27 to 120 m³/h. Ultimate vacuum at 0.5 mbar (abs.). The once through oil lubrication protects the pump chamber from corrosive vapor. Can be used in combination with a rotary lobe vacuum booster. The flange motors comply with DIN EN 60034 and have protection class IP 54 and isolation class F.



R-Series
Rotary Lobe

R-VWP

Rotary lobe vacuum pumps

Contact free operating rotary lobes with capacities ranging from 250 to 10,000 m³/h. Primarily used for producing coarse and fine vacuum and for handling gases and vapors, as they can tolerate water vapor and most corrosive gases. Mainly used in combination with backing pumps. The flange motors comply with DIN EN 60034 and have protection class IP 54 and isolation class F.

ATEX compliant pump stands and systems often contain rotary lobe pumps whose technical specifications may vary according to their use. Please get in touch with us if you need to know more.

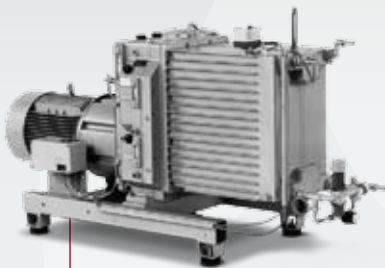

V-VWZ

up to 2G c IIB T3
up to 2G c IIB T3



V-VLV

up to 1G c IIB T4
up to 2G c IIB T3



R-VWP

on request
on request

Product overview



C-Series
Claw

C-VLR ZEPHYR

Claw vacuum pumps

Capacities ranging from 60 to 6,000 m³/h and maximum continuous vacuum up to 100, 150 and 200 mbar (abs.). Highly efficient, dry and contact free. Integrated air cooling without additional cooling medium. The flange motors comply with DIN EN 60034 and have protection class IP 54 and isolation class F.

C-DLR ZEPHYR

Claw compressors

Capacities ranging from 60 to 600 m³/h; maximum pressure in continuous operation up to 2.2 bar. Highly efficient, dry and contact free. Steady performance curve over the entire operating range. Integrated air cooling without additional cooling medium. The flange motors comply with DIN EN 60034 and have protection class IP 54 and isolation class F.



S-Series
Screw

S-VSB TWISTER

Capacities ranging from 80 to 650 m³/h, end vacuum 0.05 mbar (abs.). Screw rotors with a progressive graduation. Low noise level, easy to service. Low operating temperature. Corrosion resistant versions feature special coatings, depending on the application. Suitable for solvent recovery and drying processes in the chemical and pharma-ceutical industry.



Certified ATEX categories

C-VLR ZEPHYR

Inside	up to 3G c IIB T2/T3/T4
Outside	up to 2G c IIB T2/T3/T4

C-DLR ZEPHYR

Inside	up to 3G c IIB T2/T3/T4
Outside	up to 2G c IIB T2/T3/T4

S-VSB TWISTER

Inside	up to 1G c IIC T4
Outside	up to 2G c IIC T4



X-Series
Systems

X-L G WITTIG

Flow rates from 120 to 540 m³/h, pressure up to 2.5 bar (g), power from 10 to 40 kW. The rotary vane compressors are single-stage and air cooled. They can be driven by electric motors (explosion-proof if required) via flexible coupling or V-belt.

X-RVA G WITTIG

Flow rates from 505 to 5,262 m³/h, pressure up to 2.5 bar (g), power from 33 to 315 kW. The rotary vane compressors are water cooled and once through oil lubricated. The cooling system is checked by a flow monitor. They can be driven by electric motors (explosion-proof if required) via flexible coupling.

X-RO G WITTIG

Flow rates from 342 to 2,930 m³/h, pressure up to 10 bar (g), power from 45 to 355 kW. The rotary vane compressors are single-stage and air or water cooled. They have a low sound pressure level and can be delivered with an acoustic hood, if required. The X-RO G WITTIG can be driven by electric motors (explosion-proof if required).

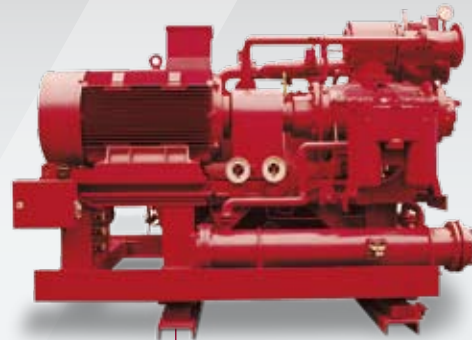

X-L G WITTIG

2G c IIB T2

2G c IIB T2

X-RVA G WITTIG

2G c IIB T2

2G c IIB T2

X-RO G WITTIG

2G c IIB T2

2G c IIB T2

Flow chart with ATEX certified screw vacuum pump

R + I flow chart S-VSB TWISTER

Tested for type screw vacuum pump for zone 0 (1)

The flow chart to the right shows the measuring and monitoring devices needed for the dry running S-VSB TWISTER screw vacuum pump which has been approved and certified for extracting gas and vapor in explosion zone 0 (category 1).

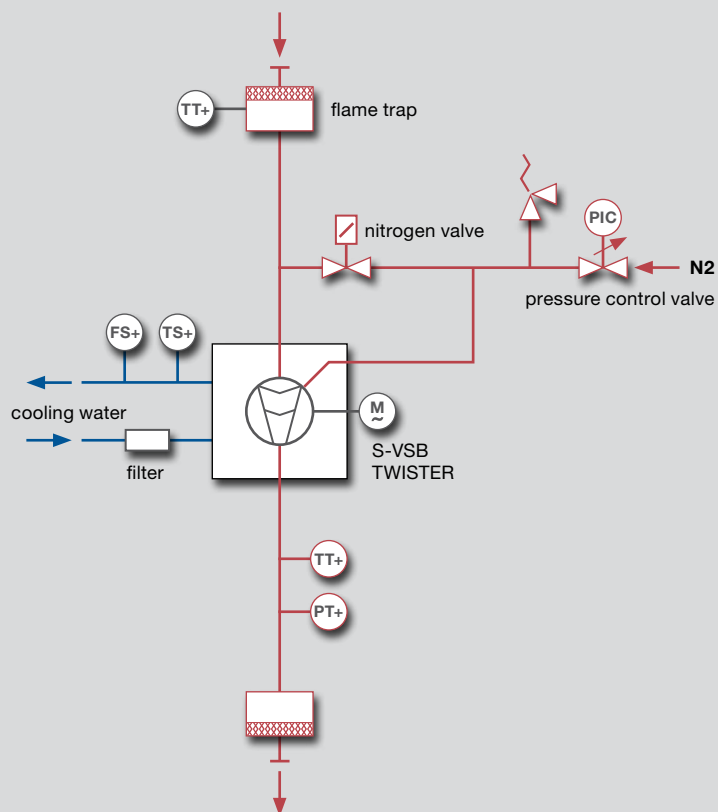

Solutions you can trust

We have a full range of products and technologies to meet your process demands – both as stand-alone units or complex systems including electronic monitoring devices and accessories. Our team of engineers will assist and support you during all stages of your project from the first steps to the final start-up.



S-VSB TWISTER
Type
Ex (i) II 1G c IIC T4
Ex (o) II 2G c IIC T4

Performance

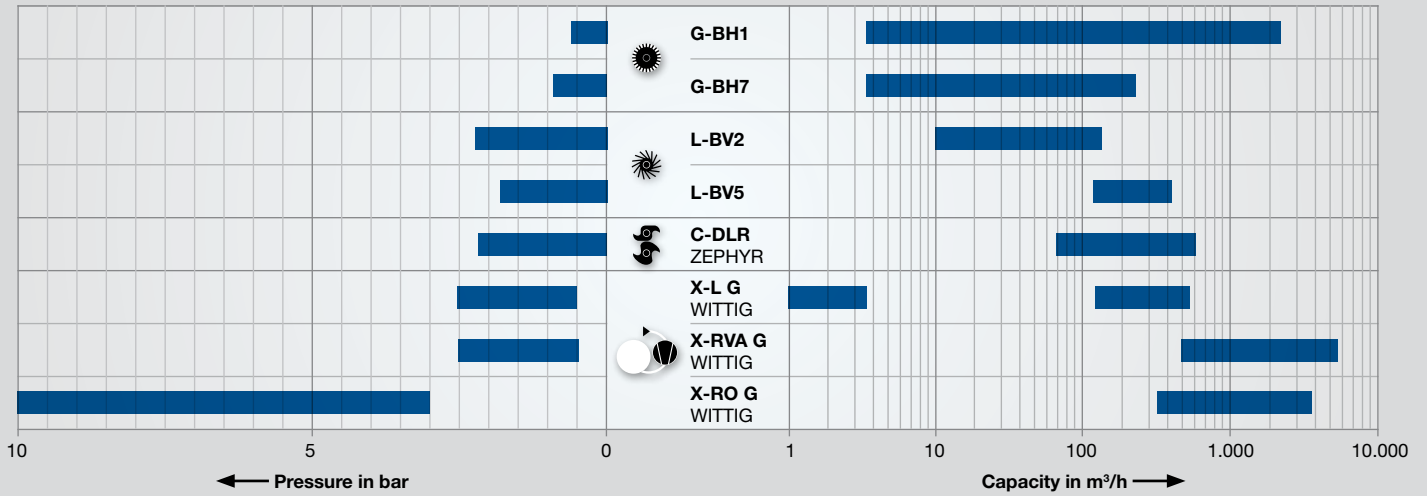
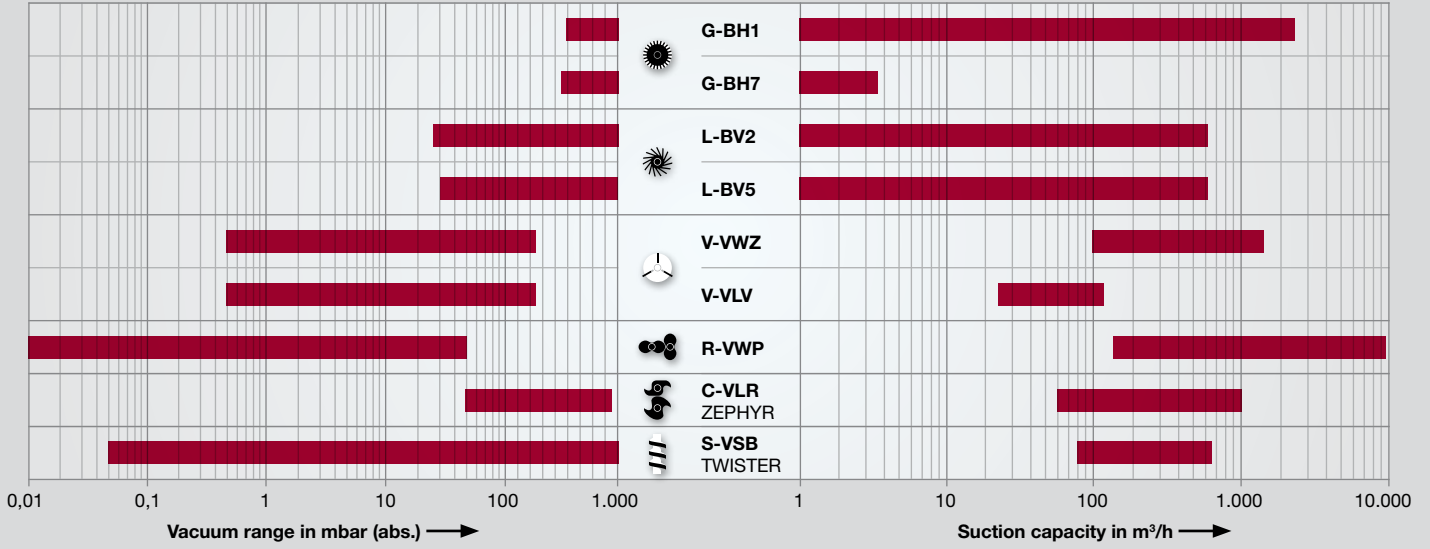



Technologies for all vacuum and pressure applications



F-Series Radial



G-Series Side Channel



L-Series Liquid Ring



V-Series Rotary Vane



R-Series Rotary Lobe



C-Series Claw



S-Series Screw



X-Series Systems

www.gd-elmorietschle.com

er.de@gardnerdenver.com

**Gardner Denver
Schopfheim GmbH**
Roggenbachstraße 58
79650 Schopfheim · Germany
Phone +49 7622 392-0
Fax +49 7622 392-300

**Gardner Denver
Deutschland GmbH**
Industriestraße 26
97616 Bad Neustadt · Germany
Phone +49 9771 6888-0
Fax +49 9771 6888-4000

**Gardner
Denver**

Elmo Rietschle is a brand of
Gardner Denver's Industrial Products
Division and part of Blower Operations.